

OS0

Short-Range High-Resolution Imaging Lidar

HARDWARE VERSION: REV8.0

APPLICABLE MODEL NUMBERS: OS0-080-XXX-X-X-002-XX

SUMMARY

The Rev8 OS1 lidar sensor features 35 m range on a 10% reflective target, native color RGB-D point cloud, 90° vertical field of view, and automotive-grade reliability for the most rugged conditions. The Rev8 OS0 is engineered for functional safety and use in AMRs, AGVs, autonomous vehicles, heavy machinery, robots, drones, and mapping solutions.

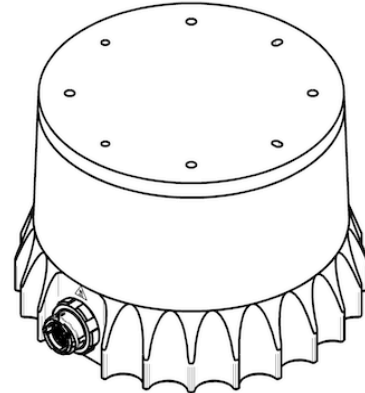

WHAT'S NEW IN REV8?

- Native color point cloud featuring RGB-D data
- Available in 4096 horizontal resolution
- Engineered for Functional Safety (ASIL-B, SIL-2, PLd) with on-sensor 3D Zone Monitor
- Extreme resistance to environmental stress upto 100 g shock, 10 G-rms vibration, and -40°C to +85°C operating temperature
- Designed for cybersecurity to ISO 21434 standard

OTHER HIGHLIGHTS

- Zero Minimum Range
- Window Blockage Detection for easy diagnostics
- Synchronous IMU
- Calibrated reflectivity
- Ouster Studio for point cloud evaluation
- Ouster SDK for software development
- ROS2, ROS, NVIDIA Driveworks, NVIDIA IsaacSim, and MATLAB support

OPTICAL PERFORMANCE

Range (80% Lambertian reflectivity, 1024 @ 10 Hz mode)	75 m @ 100 klx sunlight, >90% detection probability
Range (10% Lambertian reflectivity, 1024 @ 10 Hz mode)	35 m @ 100 klx sunlight, >90% detection probability
Max Representable Range	250 m
Minimum Range	0.0 m (0.3 m optional, and 0.5 m default)
Vertical Resolution	32, 64, or 128 channels
Horizontal Resolution	512, 1024, 2048, or 4096 (configurable)
Rotation Rate	5, 10, 15, 20, 30, or 40 Hz (configurable)
Field of View	Vertical: 90.0° (+45.0° to -45.0°) Horizontal: 360.0°
Angular Sampling Accuracy	Vertical: ±0.01° / Horizontal: ±0.01°
False Positive Rate	1/10,000
Range Resolution	0.1 cm Note: For <i>Low Data Rate Profile</i> the Range Resolution = 0.8cm
# of Returns	up to 2
Return Order	Strongest to Weakest, Farthest to Nearest, and Nearest to Farthest

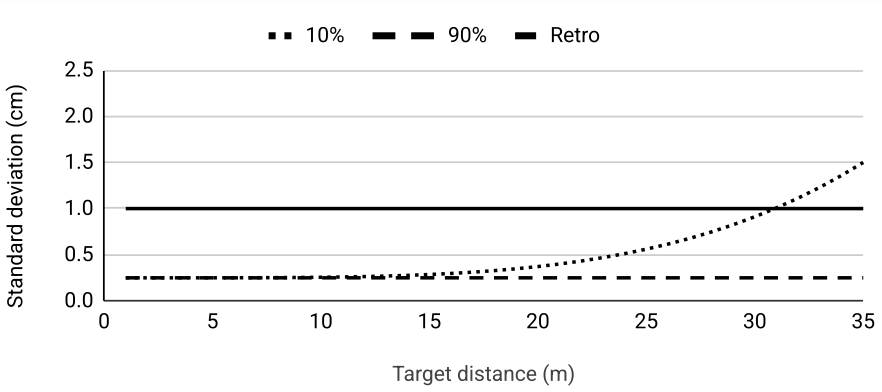
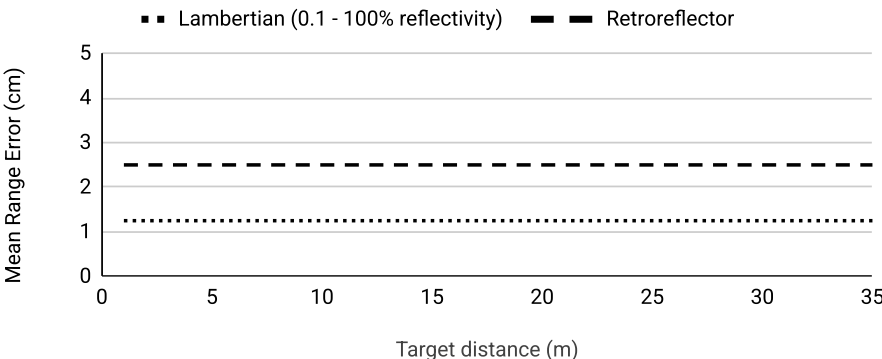
<p>Range Precision (Typical on Lambertian and Retroreflective targets beyond 1 m, 1024 @ 10 Hz mode, 1 standard deviation) Note: Precision is calculated based on the standard deviation of 100 measurements on a static target at a given range</p>	<p>Min: ± 0.25 cm, Max: ± 1.5 cm</p> 
<p>Range Accuracy (Typical on Lambertian and Retroreflective targets beyond 1 m, 1024 @ 10 Hz mode) Note: Accuracy is calculated based on the error between the mean of 100 measurements on a static target at a given range and the true range</p>	<p>± 1.25 cm for lambertian targets, ± 2.5 cm for retroreflective targets</p> 

LASER

Laser Product Class	Class 1 eye-safe per IEC/EN 60825-1: 2014
Laser Wavelength	865 nm
Beam Diameter Exiting Sensor	5 mm
Beam Divergence	0.35° (FWHM)

LIDAR OUTPUT

Connection	UDP over gigabit Ethernet
Maximum Points Per Second	10,485,760
Data Per Point	RGB, Range, Signal, Reflectivity, Near-infrared, Channel, Azimuth angle, and Timestamp
Timestamp Resolution	< 1 μ s
Data Latency	< 10 ms
Data Integrity	End to End CRC that covers entire data packet

DATA RATE (calculated at 1024 @ 10 Hz)

	32 channel	64 channel	128 channel	256 channel
Maximum Data Rate	75 Mbps	148 Mbps	295 Mbps	N/A
Minimum Data Rate	12 Mbps	22 Mbps	43 Mbps	N/A

NATIVE COLOR OUTPUT

Dynamic Range	116 dB
Lux @ SNR 10 dB	3 lux
Max measurable illuminance	2,000,000 lux
Sensitivity metamerism index (ISO 17321)	80
Bit depth	48-bit (total) or 16-bit per channel

IMU OUTPUT

Connection	UDP over 1000Base-T, 1000Base-T1 or POE+
Samples Per Second (Configurable)	640, 1280, 2560 (default)
Data Per Sample	3 axis gyro, 3 axis accelerometer
Timestamp Resolution	< 1 μ s
Data Latency	< 10 ms
Additional Details	InvenSense IAM-20685HP; datasheet for more details: https://invensense.tdk.com/products/motion-tracking/6-axis/iam-20685hp/

CONTROL INTERFACE

Connection	HTTPS API	
Time Synchronization	Input sources: <ul style="list-style-type: none">• IEEE1588 Precision Time Protocol (PTP); Accuracy: <1 ms error• gPTP; Accuracy: <1 ms error• NMEA \$GPRMC UART message support• External PPS; Accuracy: <1 ms error• Internal 10 ppm drift clock; Accuracy: <20 ppm error Output sources: <ul style="list-style-type: none">• Configurable 1 - 60 Hz output pulse	
Lidar Operating Modes (Configurable)	<ul style="list-style-type: none">• x 512 @ 10 Hz, 15 Hz, 20 Hz, 30 Hz, 40 Hz• x 1024 @ 10 Hz, 15 Hz, 20 Hz, 30 Hz, 40 Hz• x 2048 @ 10 Hz or 20 Hz• x 4096 @ 5 Hz or 10 Hz	
Additional Programmability	<ul style="list-style-type: none">• On-sensor 3D Zone Monitor• Return ordering• Minimum range• Azimuth masking• Multi-sensor phase lock	<ul style="list-style-type: none">• Queryable intrinsic calibration information:<ul style="list-style-type: none">• Beam angles• IMU pose correction matrix• Low-power standby mode

MECHANICAL/ELECTRICAL

Power Consumption (at 1024*10 Hz)	10 W to 20 W <ul style="list-style-type: none">• 15 W nominal• 22 W peak at startup if operating at -40°C Note: Ouster recommends using a power supply capable of no less than 30 W continuous power output
Connector	Side-facing proprietary bayonet-style connector with 1000BASE-T ethernet
Operating Voltage	Nominal 12 VDC or 24 VDC Capable of operating from 9 V to 58 V DC <ul style="list-style-type: none">• Maximum allowable ripple: 1 Vpp• Reverse polarity protection to -65 V• Overvoltage protection to +65 V• Suitable for automotive 12 V nominal systems (16750-2 Code C) with centralized load dump suppression not exceeding 58 V• Suitable for automotive 24 V nominal systems (16750-2 Code E) with centralized load dump suppression not exceeding 58 V• NOT suitable for automotive 48V nominal systems

Dimensions	Diameter: 87 mm (3.42 in) Height: <ul style="list-style-type: none"> • Without cap: 58.35 mm (2.3 in) • With thermal cap: 74.2 mm (2.9 in)
Weight	No halo cap / baseplate: 500 g With halo cap: 580 g
Mounting	Bottom: 4x M3 screws, 2x locating 2 mm pin holes Top: 4x M3 screws, 4x locating 2 mm pin holes, 1x M6 screw
Bottom Mount Baseplate	Aluminum, 530 g, 110 mm x 110 mm x 20.5 mm (LxWxH), 4 x M8 thru holes

OPERATIONAL

Operating Temperature (at 1024*10 Hz)	-40°C to +85°C when mounted in accordance with Ouster Thermal Intergration guide
Storage Temperature	-40°C to +105°C
Ingress Protection	IP68 (1m submersion for 1 hour, with I/O cable attached) IP69K (with I/O cable attached)
Shock	IEC 60068-2-27 (Amplitude: 100 G, Shape: 11 ms half-sine, 3 shocks x 6 directions)
Vibration	IEC 60068-2-64 (Amplitude: 10 Grms, Shape: 10 - 1000 Hz, Mounting: 3 axis @ 48hrs/axis, per ISO-16750-3 Test VII method. Ouster custom ASD derived from Test VII ASD
Compliance	<p>Functional Safety:</p> <ul style="list-style-type: none"> - IEC61508 SIL2² - ISO26262 ASIL-B¹ - ISO13849 PLd/CAT-2² <p>Security/Cybersecurity:</p> <ul style="list-style-type: none"> - ISO 21434 Automotiveⁱ - UNECE-WP 29 Automotiveⁱ - IEC 62443 Industrialⁱ - ISO 27001 <p>US and Canada</p> <p>Laser Eye Safety:</p> <ul style="list-style-type: none"> - IEC/EN 60825-1:2014 Class 1 eye safe - FDA US 21CFR1040 Laser Notice 56 Class 1 - Canada Radiation Emitting Devices Regulation (REDR) with SOR/2024-196ⁱ <p>Product Safety:</p> <ul style="list-style-type: none"> - UL 62368-1, 4th Edition - CSA 22.2 No. 62368-1-25 <p>EMC:</p> <p>Commercial: FCC Part 15 and ICES03 Class B</p> <p>European Union (EU)</p> <p>Laser Safety: IEC 60825-1:2014, EN 60825-1:2014+A11:2021 Class 1 eye safe Product Safety: IEC 62368-1:2018, EN 62368-1:2014/AC:2015</p> <p>EMC:</p> <ul style="list-style-type: none"> - EN 55032:2015 + AC:2016 + A11:2020 + A1:2020 Class B - EN 61000-3-2:2014 - EN 61000-3-3:2013 - EN 55035:2017 + AC:2019 + A11:2020 <p>Automotive:</p> <ul style="list-style-type: none"> - GMW3097:2019ⁱ - UN-ECE Reg 10, Rev 6 <p>Earthmoving/Construction equipment:</p> <ul style="list-style-type: none"> - ISO-13766-1:2018 - ISO-13766-2:2018

Note: Ouster UK (Ltd): 125 Princes Street,
Edinburgh EH2 4AD, Scotland, United Kingdom
Contact: Neil Calder
Phone Number: +44(0).131.563.9078

Industrial Trucks/Forklift:
- IEC/EN-12895:2015+A1:2019¹ ²

Agricultural equipment:
- ISO 14982:2009¹

Australia:
AS/NZS CISPR 32: 2015 + AMD1: 2020



¹ Pending certification, ² Available in an alternate configuration

SOFTWARE





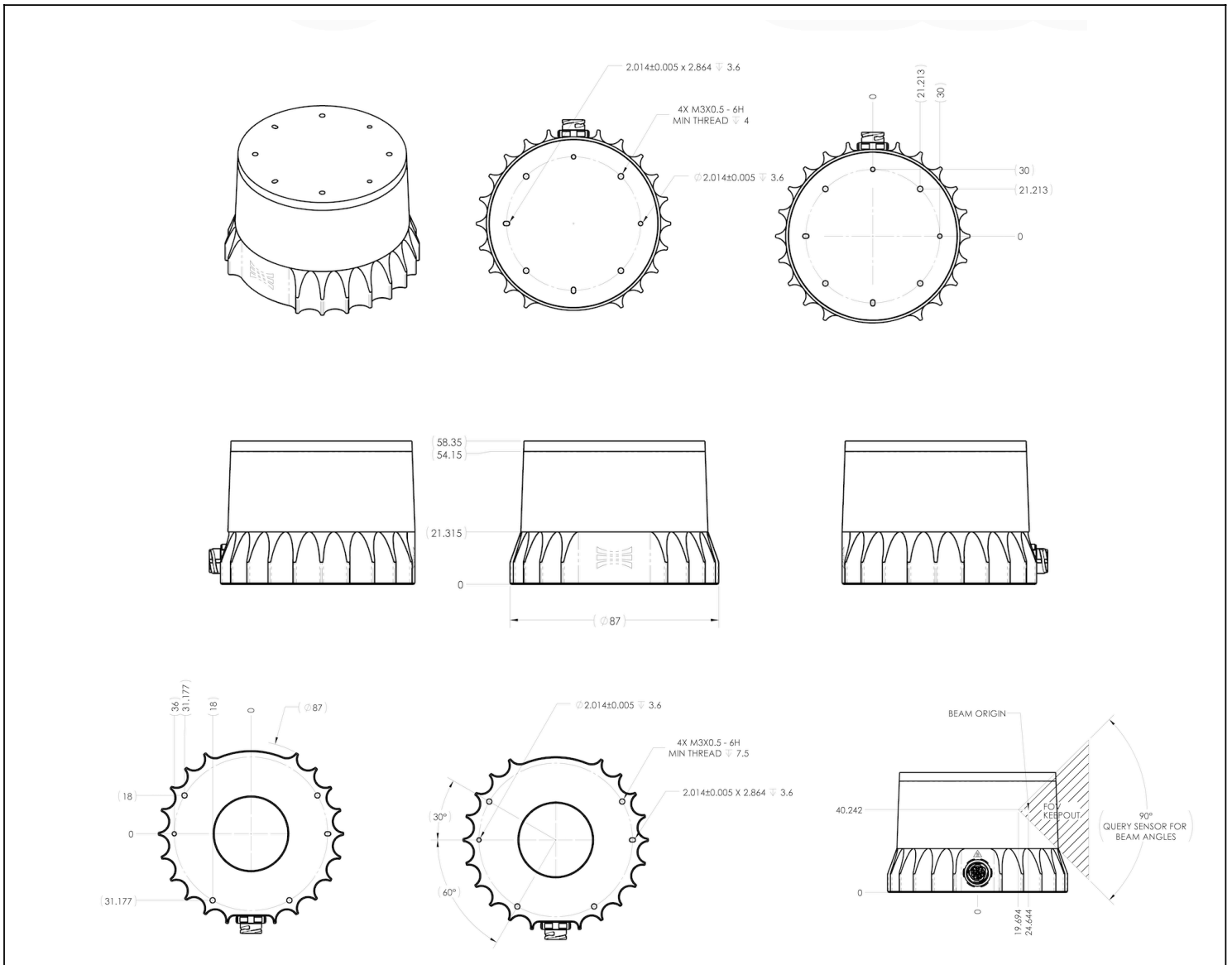



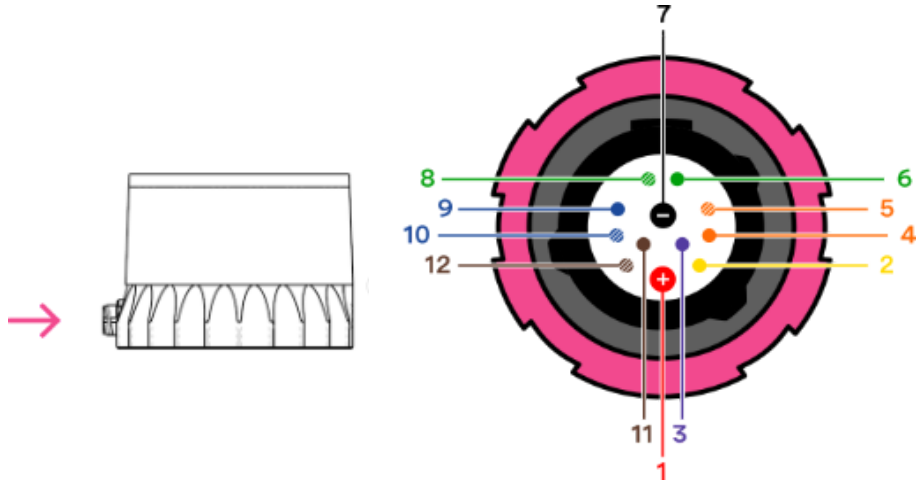

Ouster Software	Ouster Python SDK, C++ Driver, Ouster Studio
Supported 3rd Party Integrations	ROS2, ROS, NVIDIA Driveworks, MATLAB, NVIDIA Isaac, NVIDIA IsaacSIM

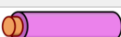
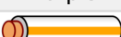
EXTERIOR DIMENSIONS

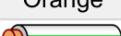

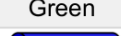
CABLE & CONNECTOR PINOUT DIAGRAM FOR TYPE 3 (1000BASE-T)

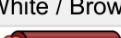

Pin	Function	Signal Name	Wire Color	Twisted With	Wire Gauge
1	Power	PWR	 Red	N/A	18 AWG
7		GND	 Black		
2	Multipurpose I/O	MIO0	 Yellow	N/A	28 AWG
3		MIO1	 Purple		
5	Ethernet	BI_DA+	 White / Orange		
4		BI_DA-	 Orange		
8		BI_DB+	 White / Green		
6		BI_DB-	 Green		
9		BI_DC+	 Blue		
10		BI_DC-	 White / Blue		
12		BI_DD+	 White / Brown		
11		BI_DD-	 Brown		

*Specifications are subject to change without notice.

All specifications and certifications are preliminary and apply only to the part number specified above. Please refer to the latest datasheet at time of purchase to confirm specifications. Ouster reserves the right to update, improve, modify or otherwise change its specs at any time without notice. All performance figures and data represent typical values under testing and actual product performance may vary based on environmental conditions.

WWW.OUSTER.COM

REV: 05/04/2026 • © 2026 Ouster, Inc. • All rights reserved